



MASTERLINE
by Bisk

CATALOGUE / KATALOG

2017

TABLE OF CONTENTS SPIS TREŚCI

- 04 **Paper dispensers**
Podajniki na papier
- 05 **Automatic dryers**
Suszarki automatyczne
- 06 **Soap dispensers**
Dozowniki mydła
- 09 **Waste baskets**
Kosze na śmieci
- 10 **Exploataion materials**
Materiały eksploatacyjne
- 10 **Supplementary accessories**
Akcesoria uzupełniające
- 13 **PRO Handicap accessories**
Akcesoria PRO dla niepełnosprawnych
- 16 **Selected BISK bathroom accessories**
Wybór akcesoriów łazienkowych BISK





MASTERLINE by BISK is a brand dedicated to the institutional clients and is part of the BISK SA Group, a long-established Polish producer of bathroom accessories present on all major European markets. With the experience gathered over the years we came to the decision of launching this range of products, which through rigorous quality control and universal design perfectly fit into the nature of public space.

MASTERLINE

by Bisk

MASTERLINE by BISK to marka dedykowana klientom instytucjonalnym, wchodząca w skład portfolio Grupy BISK S.A., polskiego producenta akcesoriów łazienkowych, działającego na wszystkich najważniejszych rynkach europejskich. Zgromadzone przez lata doświadczenie Grupy zaowocowało stworzeniem gamy produktów, które poprzez rygorystyczną kontrolę jakości oraz uniwersalne wzornictwo doskonale wpisują się w charakter przestrzeni publicznej.



PAPER DISPENSERS PODAJNIKI NA PAPIER

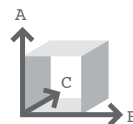

MASTERLINE
by Bisk



03863

PRP-1
PP
white/biały
A 165 B 270 C 150
paper rolls Ø14 cm
rolki papieru Ø14 cm
paper towels
250 pcs, 25x23 cm
papier w listkach
250 szt., 25x23 cm



04305

PU-P1
ABS
white/biały
A 290 B 150 C 140
for toilet rolls 2x Ø12 cm
rolki papieru 2x Ø12 cm
paper towels 11,5x12,5 cm
papier w listkach 11,5x12,5 cm



00398

PL-P2
ABS
silver matt/srebrny mat
A 263 B 294 C 148
paper towels
500 pcs, 25x23 cm
papier w listkach
500 szt., 25x23 cm



00344

PL-P1
ABS
white/biały
A 263 B 294 C 148
paper towels
500 pcs, 25x23 cm
papier w listkach
500 szt., 25x23 cm



00505

Jumbo-P2
ABS
silver matt/srebrny mat
A 267 B 258 C 117
for toilet rolls max Ø 23 cm
rolki papieru max Ø 23 cm



00399

Jumbo-P1
ABS
white/biały
A 267 B 258 C 117
for toilet rolls max Ø 23 cm
rolki papieru max Ø 23 cm



01570

Jumbo-S2
stainless steel/stal nierdzewna
chrome/chrom
A 266 B 254 C 120
for toilet rolls max Ø 23 cm
rolki papieru max Ø 23 cm



00343

Jumbo-S1
stainless steel/stal nierdzewna
brushed/szczotkowana
A 262 B 254 C 120
for toilet rolls max Ø 23 cm
rolki papieru max Ø 23 cm



01571

PL-S2
stainless steel/stal nierdzewna
chrome/chrom
A 266 B 284 C 100
paper towels
500 pcs, 25x23 cm
papier w listkach
500 szt., 25x23 cm



00342

PL-S1
stainless steel/stal nierdzewna
brushed/szczotkowana
A 266 B 284 C 100
paper towels
500 pcs, 25x23 cm
papier w listkach
500 szt., 25x23 cm

AUTOMATIC DRYERS SUSZARKI AUTOMATYCZNE

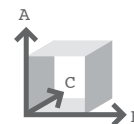

MASTERLINE
by Bisk



01801

SRM-S1
stainless steel/stal nierdzewna
brushed/szczotkowana
A 235 B 260 C 145
2300W, 78dB

CE



01574

SR-P2
ABS
silver matt/srebrny mat
A 300 B 240 C 145
1200W, 63dB

CE



01569

SR-S2
stainless steel/stal nierdzewna
chrome/chrom
A 280 B 220 C 150
1650W, 63dB

CE



00194

SR-P1
ABS
white/biała
A 300 B 240 C 145
1200W, 63dB

CE



00195

SR-S1
stainless steel/stal nierdzewna
brushed/szczotkowana
A 280 B 220 C 150
1650W, 63dB

CE



00241

SU-P1
ABS
white/biały
A 255 B 180 C 145
800W, 67dB

CE



01802

SH-P1
ABS
white/biały
A 220 B 90 C 145
1200W, 75dB

CE



SOAP DISPENSERS DOZOWNIKI MYDŁA

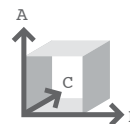

also for disinfection gel & liquid
także do: żel i płyn dezynfekujący

MASTERLINE
by Bisk



**NEW
2017**



06389

DM1
stainless steel/stal nierdzewna
brushed/szczotkowana
A 230 B 105 C 100
500 ml

**NEW
2017**



06390

DM2
stainless steel/stal nierdzewna
chrome/chrom
A 230 B 105 C 100
500 ml

**NEW
2017**



06391

DPM1
stainless steel/stal nierdzewna
brushed/szczotkowana
A 230 B 105 C 100
500 ml



04957

D1
stainless steel/stal nierdzewna
brushed/szczotkowana
A 295 B 97 C 105
1000 ml



05880

D2
stainless steel/stal nierdzewna
chrome/chrom
A 295 B 97 C 105
1000 ml



04959

DP1
stainless steel/stal nierdzewna
brushed/szczotkowana
A 295 B 97 C 105
1000 ml



01415

stainless steel/stal nierdzewna
chrome/chrom
A 153 B 98 C 98
500 ml



04084

stainless steel/stal nierdzewna
brushed/szczotkowany
A 150 B 103 C 105
500 ml



01416

stainless steel/stal nierdzewna
chrome/chrom
A 202 B 125 C 107
1000 ml



01417

stainless steel/stal nierdzewna
brushed/szczotkowana
A 202 B 125 C 107
1000 ml



SOAP DISPENSERS DOZOWNIKI MYDŁA

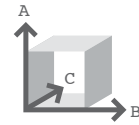

no-touch system
bezdotykowy



also for disinfection gel & liquid
także do: żel i płyn dezynfekujący

MASTERLINE
by Bisk



05903

AK1 / ABS
white/biały
A 217 B 110 C 100
500 ml



05904

AK2 / ABS
silver matt/srebrny mat
A 217 B 110 C 100
500 ml



05905

AK3 / ABS
chrome/chrom
A 217 B 110 C 100
500 ml



00588

ABS
white/biały
A 217 B 110 C 100
500 ml



00589

ABS
silver matt/srebrny mat
A 217 B 110 C 100
500 ml



**NEW
2017**

06672

AS1 / stainless steel / stal nierdzewna / ABS
chrome/chrom
A 185 B 110 C 75
225 ml



02280

L1 / ABS
white/biały

02281

L2 / ABS
silver matt/srebrny mat
A 275 B 110 C 105
1000 ml



02275

K1 / ABS
white/biały

02276

K2 / ABS
silver matt/srebrny mat
A 208 B 90 C 100
500 ml



03558

ABS
white/biały
A 210 B 97 C 104
500 ml



02923

P1 / ABS
white/biały

03133

P2 / ABS
silver matt/srebrny mat
A 210 B 98 C 115
750 ml





SOAP DISPENSERS DOZOWNIKI MYDŁA

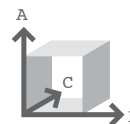

MASTERLINE
by Bisk



72027

ABS
white/biały
A 195 B 80 C 80
350 ml



72067

ABS
silver matt/srebrny mat
A 195 B 80 C 80
350 ml



72075

ABS
chrome/chrom
A 195 B 80 C 80
350 ml



00174

ABS
white/biały
A 250 B 138 C 80
2x400 ml



00175

ABS
chrome/chrom
A 250 B 138 C 80
2x400 ml



00173

ABS
chrome/chrom
A 250 B 84 C 80
400 ml



00172

ABS
white/biały
A 250 B 84 C 80
400 ml



07402

A1 / ABS
white/biały
A 157 B 98 C 85
500 ml



07517

A2 / ABS
silver matt/srebrny mat
A 157 B 98 C 85
500 ml



07600

A3 / ABS
chrome/chrom
A 157 B 98 C 85
500 ml



07802

C / ABS
white/biały
A 190 B 113 C 110
1000 ml



04760

BL1 / solid brass / mosiądz
brushed nickel / nikiel szczotkowany

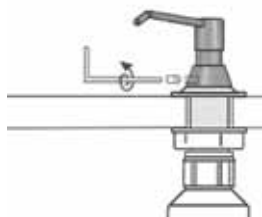

04759

BL2 / solid brass / mosiądz
chrome / chrom
A 448 B 180 C 90
1000 ml



07702

B / ABS
white/biały
A 280 B 81 C 113
1000 ml

WASTE BASKETS KOSZE NA ŚMIECI

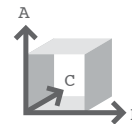

STAINLESS STEEL / STAL NIERDZEWNA

MASTERLINE
by Bisk

CHROME/CHROM



00057 3l

A 265 B 165 C 225

00283 5l

A 280 B 205 C 260

00056 7l

A 315 B 205 C 260

00430 12l

A 395 B 320 C 250

00060 20l

A 445 B 365 C 305

BRUSHED/SZCZOTKOWANA



00125 3l

A 265 B 165 C 225

03275 5l

A 280 B 105 C 260

00431 12l

A 395 B 320 C 250

01017 20l

A 445 B 365 C 305



00122 6l

chrome/chrom
A 295 B 205 C 250

04045 >



04045

lid/pokrywa kosza

00390 >

00390 35l

brushed/szczotkowana
A 490 B 420 C 190

▲ wall mounted/mocowany do ściany

POLIPROPYLENE/POLIPROPYLEN



91927 10l

white/biały
A 410 B 240 C 240



93002 15l

white/biały
A 500 B 275 C 275



93902 8l

white/biały
A 370 B 250 C 230



90302 5l

white/biały
A 300 B 200 C 200

BISK CATALOGUE
KATALOG BISK

2017



EXPLOATATION MATERIALS MATERIAŁY EKSPLOATACYJNE



03353

MINI - Ø 14 cm
length/długość - 60 m



03354

MINI - Ø 14 cm
length/długość - 65 m



03355

JUMBO - Ø 18,5 cm
length/długość - 120 m



05890

ZZ
size/rozmiar: 25x23 cm



03158 5l

soft foam soap/mydło w pianie



02795 5l

liquid soap/mydło w płynie



02796 1l

liquid soap/mydło w płynie

SUPPLEMENTARY ACCESSORIES AKCESORIA UZUPEŁNIAJĄCE

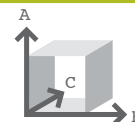

STAINLESS STEEL / STAL NIERDZEWNA

MASTERLINE
by Bisk



71275

chrome/chrom

04790

white/biały

71276

brushed/szczotkowana
A 55 B 265 C 70
Ø 19 mm



01419

brushed/szczotkowana
A 60 B 130 C 10



71851

brushed/szczotkowana
A 55 B 335 C 80
Ø 22 mm

04811

white/biały

71850

chrome/chrom



01418

chrome/chrom
A 60 B 130 C 10



04791

white/biały

71875

chrome/chrom

71876

brushed/szczotkowana
A 240 B 380 C 80
Ø 25 mm



00102

chrome/chrom
A 55 B 640 C 80
Ø 25 mm



71925

chrome/chrom

71926

brushed/szczotkowana
A 200 B 440 C 115
Ø 25 mm



04812

white/biały
A 55 B 640 C 80
Ø 25 mm

SUPPLEMENTARY ACCESSORIES

AKCESORIA UZUPEŁNIAJĄCE

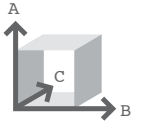

STAINLESS STEEL / STAL NIERDZEWNA

MASTERLINE
by Bisk



00046

chrome/chrom
A 30 B 135 C 90

00047

chrome/chrom
A 30 B 205 C 95



00045

chrome/chrom
A 30 B 235 C 170

00044

chrome/chrom
A 30 B 195 C 120



00048

chrome/chrom
A 335 B 235 C 170



02542

brushed nickel/szczotkowany nikiel
A 140 B 550 C 232

02543

chrome/chrom



00042

chrome/chrom
A 180 B 625 C 275



aluminium

00081

chrome/chrom
90x90x90cm, Ø 20mm



aluminium

72502

white/biały
90x90x90cm, Ø 20mm



00080

stainless steel/stal nierdzewna
chrome/chrom
70x120cm, Ø 22mm

00037

stainless steel/stal nierdzewna
chrome/chrom
125x220cm, Ø 22mm



72202

aluminium
white/biały
70x120cm, Ø 22mm

72402

aluminium
white/biały
125x220cm, Ø 22mm



set of 12pcs/kpl.12szt.

91202

plastic/plastik
white/biały

97200

plastic/plastik
transparent/przezroczysty



08702 TXT

white/biały
180x200 cm



03502 PEVA

white/biały
180x200 cm

SUPPLEMENTARY ACCESSORIES

AKCESORIA UZUPEŁNIAJĄCE

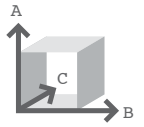

MASTERLINE
by Bisk

▲ wall mounted/mocowana do ściany



04456

SW-1/stainless steel/stal nierdzewna
brushed/szczotkowana
A 395 B 95 C 100

▲ wall mounted/mocowana do ściany



05923

SW-2/stainless steel/stal nierdzewna
chrome/chrom
A 395 B 95 C 100



00176

stainless steel/stal nierdzewna
chrome/chrom
A 265 B 100 C 100



00234

stainless steel/stal nierdzewna
brushed/szczotkowana
A 265 B 100 C 100

▲ wall mounted/mocowana do ściany



05924

SN-1/stainless steel/stal nierdzewna
brushed/szczotkowana
A 382 B 85 C 94

▲ wall mounted/mocowana do ściany



05925

SN-2/stainless steel/stal nierdzewna
chrome/chrom
A 382 B 85 C 94



00119

stainless steel/stal nierdzewna
chrome/chrom
A 270 B 110 C 110



00121

stainless steel/stal nierdzewna
brushed/szczotkowana
A 270 B 110 C 110

▲ wall mounted/mocowana do ściany



01016

stainless steel/stal nierdzewna
brushed/szczotkowana
A 267 B 95 C 110

▲ wall mounted/mocowana do ściany



71429

stainless steel/stal nierdzewna
chrome/chrom
A 267 B 95 C 110



02722 PP

white/biały
A 400 B 120 C 120



93702 PP

white/biały
A 370 B 125 C 125



80502 PP

white/biały
A 400 B 160 C 160

BABY CHANGING TABLE / PRZEWIJAK DLA DZIECKA

Article available on request / Towar dostępny na zamówienie

NEW
2017

06217

horizontal/poziom
A 512 B 872 C 513



NEW
2017

06216

vertical/pion
A 899 B 560 C 903





Safety
Regular
Production
Surveillance
www.tuv.com
td 000045927

gwarancja
LAT
5
YEARS
Guarantee

Safe home



Bezpieczny dom

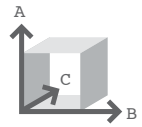

technical drawings - p. 21
rysunki techniczne - str. 21

stainless steel/stal nierdzewna
Ø 25 mm

max 150 kg
test 180 kg



04779

chrome/chrom
250 mm

04781

400 mm

04783

600 mm



04778

white/biały
250 mm

04780

400 mm

04782

600 mm

stainless steel/stal nierdzewna
Ø 25 mm

max 150 kg
test 180 kg

05499

chrome/chrom
600 mm



05498

white/biały
600 mm



04785

chrome/chrom
550x550 mm

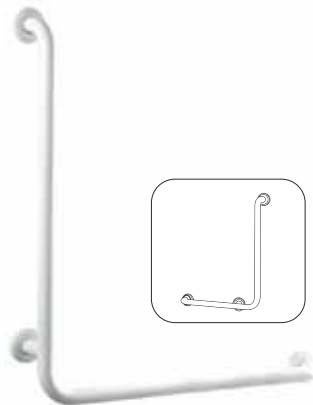

04784

white/biały
550x550 mm

stainless steel/stal nierdzewna
Ø 25 mm

max 120 kg
test 180 kg

04787

chrome/chrom
700 mm



04786

white/biały
700 mm



04777

chrome/chrom
220x220 mm



04776

white/biały
220x220 mm



installation
montaż

max 150 kg
test 180 kg



04788

AI/ABS
A 103 B 320 C 328



Atest PZH

Carry the CE mark, have hygienic approval from the National Institute of Hygiene of the Polish Institute of Public Health, are registered with The Office for Registration of Medicinal Products, Medical Devices and Biocidal Products as Class I medical devices.

Wyroby zarejestrowane w Urzędzie Rejestracji Produktów Leczniczych, Wyrobów Medycznych i Produktów Biobójczych jako Wyrób Medyczny Klasy I.

MASTERLINE *by Bisk*



Safety
Regular
Production
Surveillance
www.tuv.com
ID: 000045827

LAT
5
Gwarancja
YEARS
Gwarantee

max 150 kg
test 180 kg



06218

AI/PE
A 180 B 720-820 C 280

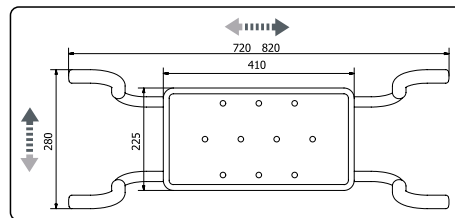

Atest PZH

Carry the CE mark, have hygienic approval from the National Institute of Hygiene of the Polish Institute of Public Health, are registered with The Office for Registration of Medicinal Products, Medical Devices and Biocidal Products as Class I medical devices.

Wyroby zarejestrowane w Urzędzie Rejestracji Produktów Leczniczych, Wyrobów Medycznych i Produktów Biobójczych jako Wyrób Medyczny Klasy I.



Safety
Regular
Production
Surveillance
www.tuv.com
ID: 000045827

LAT
5
Gwarancja
YEARS
Gwarantee

max 150 kg
test 180 kg



max 526 mm
min 348 mm

04813

AI/PE
A 348-526 B 440 C 440

Atest PZH



Safety
Regular
Production
Surveillance
www.tuv.com
ID: 000045827

stainless steel/stal nierdzewna
chrome/chrom



680 mm

04956

A 680 B 103 C 103

max 130 kg



04965

A 255 B 260 C 50

HANDICAP ACCESSORIES

AKCESORIA DLA NIEPEŁNOSPRAWNYCH

MASTERLINE
by Bisk

Article available on request / Towar dostępny na zamówienie



stainless steel/stal nierdzewna

00163

chrome/chrom
60 cm, Ø30 mm



painted steel/stal malowana

01398

white/biały
60 cm, Ø25 mm



stainless steel/stal nierdzewna

00167

chrome/chrom, Ø30 mm
75 x 80 cm, right/prawy

01384

chrome/chrom, Ø30 mm
75 x 80 cm, left/lewy



painted steel/stal malowana

01400

white/biały, Ø25 mm
75 x 60 cm, right/prawy

01524

white/biały, Ø25 mm
75 x 60 cm, left/lewy



stainless steel/stal nierdzewna

00165

chrome/chrom, Ø30 mm
55 cm, right/prawy

00166

chrome/chrom, Ø30 mm
55 cm, left/lewy



stainless steel/stal nierdzewna

01385

chrome/chrom
60 x 60 cm



painted steel/stal malowana

01390

white/biały, Ø25 mm
50 cm, right/prawy

01391

white/biały, Ø25 mm
50 cm, left/lewy



stainless steel/stal nierdzewna

01386

45 x 40 cm
chrome/chrom, Ø25 mm

painted steel/stal malowana

01527

45 x 40 cm
white/biały, Ø25 mm



reddot design award
winner 2012

5 YEARS
LAT
guarantee

SELECTED COLLECTIONS WYBRANE KOLEKCJE

MASTERLINE *by Bisk*

BLACK SATIN / CZARNA SATYNA

FUTURA



02953



02962



02959



02963



02969



02961



02954



02960



02957



02965



02952



02968



02966 (460)



02956



02967 (610)



02958

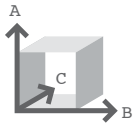

SELECTED COLLECTIONS

WYBRANE KOLEKCJE

MASTERLINE
by Bisk

CHROME / CHROM

FOR YOU



01177

A 175 B 125 C 90



02943

A 60 B 110 C 65



01176

A 45 B 155 C 90



01173

A 45 B 70 C 60



02924

A 70 B 110 C 130



03038

A 100 B 155 C 65



01174

A 95 B 125 C 85



01175

A 95 B 190 C 85

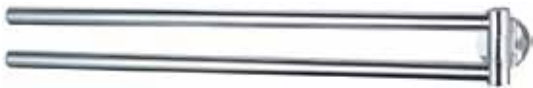

04751

A 64 B 470 C 38



01180

A 45 B 640 C 65



01181

A 45 B 610 C 115



01183

A 45 B 525 C 155



01178

A 165 B 160 C 65



01179

A 125 B 160 C 65



01182

A 375 B 165 C 125

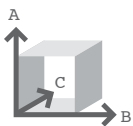

SELECTED COLLECTIONS

WYBRANE KOLEKCJE

MASTERLINE
by Bisk

DEDICATED FAUCET COLLECTION
DEDYKOWANA KOLEKCJA ARMATURY

CHROME/CHROM

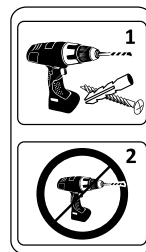

ARKTIC

01465

A 95 B 68 C 128

01464

A 50 B 200 C 30

5 YEARS GUARANTEE
LAT GWARANCJI

02228

solid brass/mosiądz
single lever bidet mixer
bateria bidetowa
A 125 B 55 C 132

5 YEARS GUARANTEE
LAT GWARANCJI

00269

solid brass/mosiądz
single lever, high neck, basin mixer
bateria umywalkowa wysoka
A 295 B 55 C 170

01467

A 70 B 135 C 130

01476

A 155 B 65 C 120

5 YEARS GUARANTEE
LAT GWARANCJI

00267

solid brass/mosiądz
single lever basin mixer
bateria umywalkowa niska
A 170 B 55 C 170

01461

A 50 B 500 C 128

01469

A 50 B 510 C 75

01463

A 50 B 85 C 50

5 YEARS GUARANTEE
LAT GWARANCJI

00270

solid brass/mosiądz
single lever shower mixer
bateria wannowa
A 130 B 210 C 110

00131

BISK FEST glue
klej BISK FEST

01473

A 145 B 125 C 40

5 YEARS GUARANTEE
LAT GWARANCJI

00271

solid brass/mosiądz
single lever bath mixer
bateria prysznicowa
A 100 B 192 C 108

01474

A 253 B 75 C 50

01475

A 385 B 115 C 165

00699

shower set/zestaw natryskowy
BISK FEST glue/klej BISK FEST
easy to fix/łatwy montaż
A 600 B 55 C 110

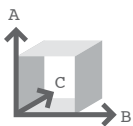

SELECTED COLLECTIONS

WYBRANE KOLEKCJE

MASTERLINE
by Bisk

DEDICATED FAUCET COLLECTION
DEDYKOWANA KOLEKCJA ARMATURY

BRUSHED NICKEL / SZCZOTKOWANY NIKIEL

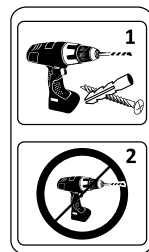

* installation with screws
montaż przy pomocy śrub

VIRGINIA



72080

A 90 B 66 C 110



72077

A 60 B 70 C 50

5 YEARS GUARANTEE
LAT GWARANCJI



02229

solid brass/mosiądz
single lever bidet mixer
bateria bidetowa
A 140 B 57 C 135



72082

A 60 B 135 C 125



72089

A 155 B 65 C 115

5 YEARS GUARANTEE
LAT GWARANCJI



00278

solid brass/mosiądz
single lever basin mixer
bateria umywalkowa niska
A 150 B 57 C 165

5 YEARS GUARANTEE
LAT GWARANCJI



00285

solid brass/mosiądz
single lever, high neck, basin mixer
bateria umywalkowa wysoka
A 305 B 57 C 165



72142*

A 50 B 210 C 30



72079

A 130 B 140 C 55

5 YEARS GUARANTEE
LAT GWARANCJI



00300

solid brass/mosiądz
single lever bath mixer
bateria wannowa
A 60 B 255 C 205



72076

A 60 B 605 C 155

5 YEARS GUARANTEE
LAT GWARANCJI



00305

solid brass/mosiądz
single lever shower mixer
bateria prysznicowa
A 60 B 255 C 145



72087

A 60 B 620 C 160



72092

A 60 B 70 C 165



72088

A 375 B 115 C 155



00181

shower set/zestaw natryskowy
BISK FEST glue/klej BISK FEST
easy to fix/łatwy montaż
A 600 B 70 C 200

SELECTED COLLECTIONS

WYBRANE KOLEKCJE

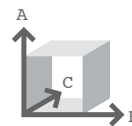

MASTERLINE
by Bisk

POLYSTERENE / POLISTYREN

OCEANIC



46842

A 60 B 45 C 40



41142

A 78 B 325 C 70



40842

A 35 B 120 C 35



47242

A 100 B 185 C 105



40742

A 100 B 120 C 120



40442

A 130 B 160 C 70



41042

A 50 B 580 C 140



47142

A 90 B 235 C 75



40542

A 40 B 160 C 110



40242

A 60 B 585 C 140



47042

A 85 B 585 C 90



51302

A 40 B 440 C 440

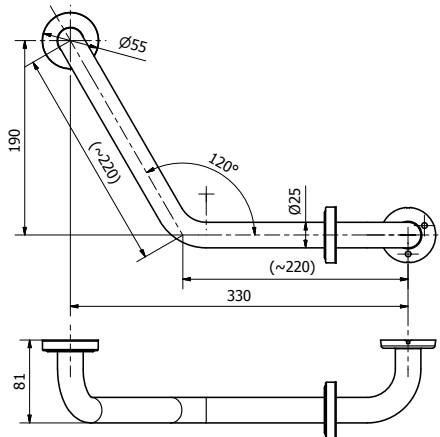

04777

04776

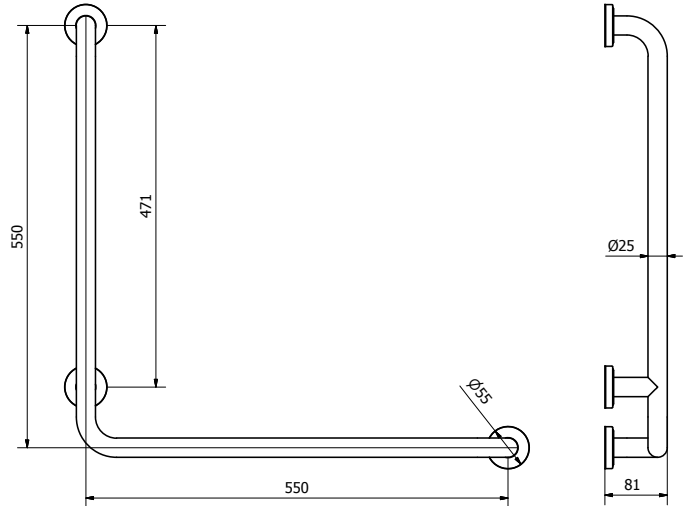

04785

04784

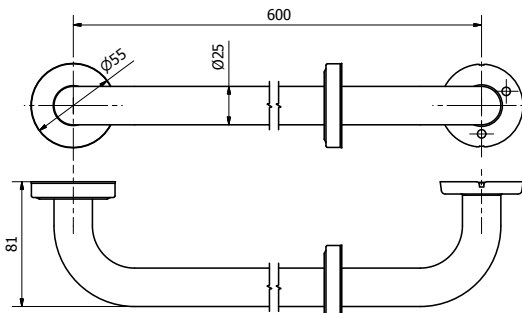

04783

04782

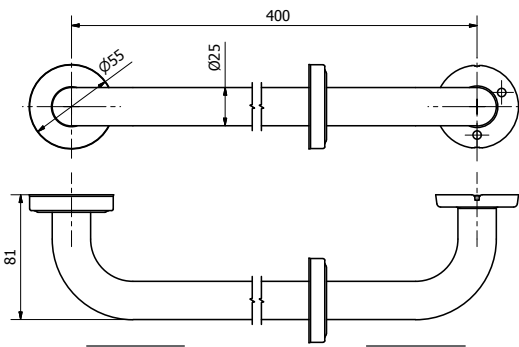

04781

04780

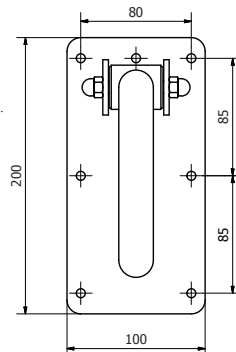

04787

04786

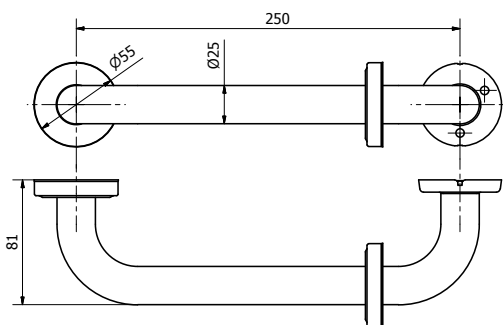
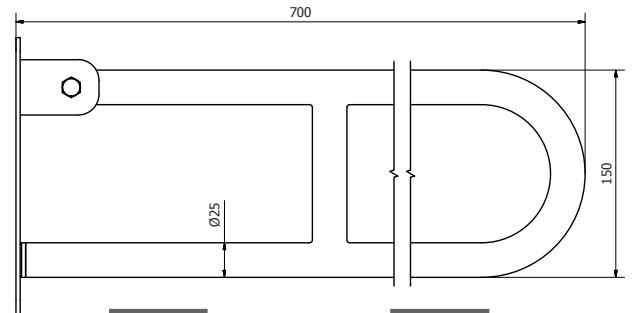

04779

04778

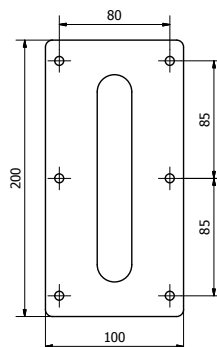

05498

05499

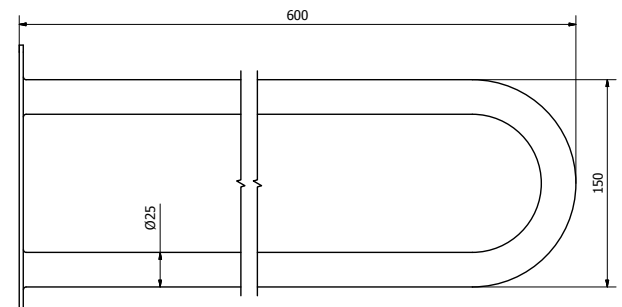







BISK S.A. | ul. Podleśna 19, Łubna, 05-532 Baniocha, Poland
tel. +48 22 736 46 01, fax +48 22 750 36 20, e-mail: bisk@bisk.eu, www.bisk.eu